

Features

- ◆ Working voltage :8.0V
- ◆ Low leakage current :1.0μA @ V_{RWM}
- ◆ Low clamping voltage
- ◆ Response Time is < 1 ns

SOD-323

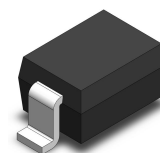

Applications

- ◆ Cell Phone Handsets and Accessories
- ◆ Microprocessor based equipment
- ◆ Personal Digital Assistants (PDA's)
- ◆ Notebooks, Desktops, and Servers

Pin Configuration

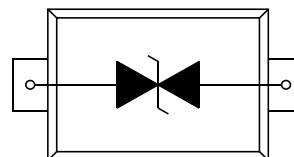

Mechanical Characteristics

- ◆ SOD-323 Package
- ◆ Molding Compound Flammability Rating : UL 94V-0
- ◆ Quantity Per Reel : 3,000pcs
- ◆ Reel Size : 7 inch

Ordering information

Device	Marking
SE08D3V01GZ	8B

Absolute Maximum Rating

Symbol	Parameter	Value	Units
T_J	Operating Junction Temperature	150	°C
T_{STG}	Storage Temperature Range	-40 to +150	°C
I_{PP}	Peak Pulse Current ($t_p = 8/20\mu s$)	15	A
V_{ESD}	ESD per IEC 61000-4-2 (Air)	±15KV	KV
	ESD per IEC 61000-4-2 (Contact)	±8KV	

I-V Curve Characteristics

Symbol	Parameter
I_{PP}	Maximum Reverse Peak Pulse Current
V_C	Clamping Voltage @ I_{PP}
V_{RWM}	Working Peak Reverse Voltage
I_R	Maximum Reverse leakage Current @ V_{RWM}
V_{BR}	Breakdown Voltage @ I_T
I_T	Test Current

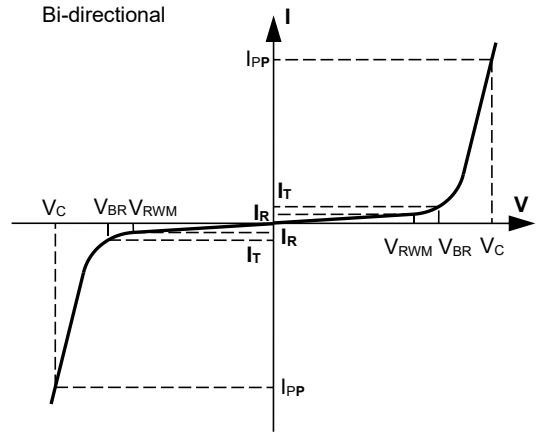

Electrical Characteristics (@ $T_A=25^\circ C$)

Parameter	Symbol	Test Conditions	Min.	Typ.	Max.	Unit
Reverse Working Voltage	V_{RWM}	--	--	--	8.0	V
Reverse Breakdown Voltage	V_{BR}	$I_T = 1mA$	--	9.1	11	V
Reverse Leakage Current	I_R	$V_{RWM} = 8V$	--	--	1.0	μA
Clamping Voltage	V_C	$I_{PP} = 15A, t_P = 8/20\mu s$	--	17.5	20	V
Junction Capacitance	C_J	$V_R = 0V, f = 1MHz$	--	130	--	pF

Typical characteristic curve

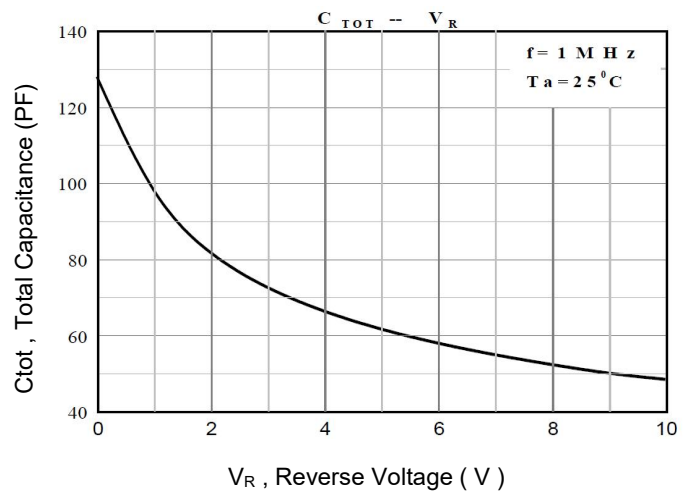
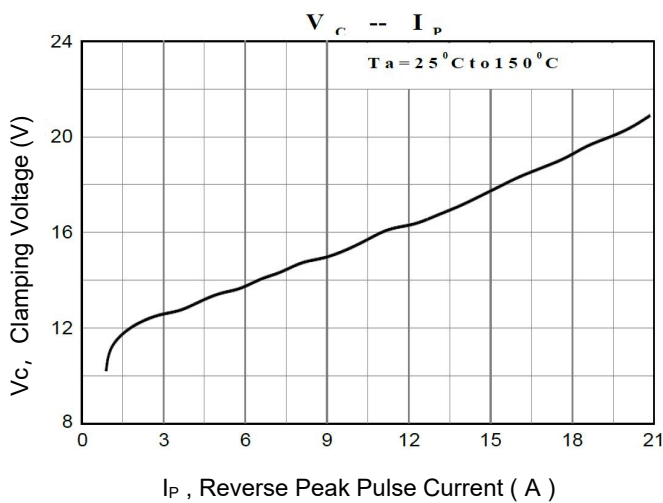

SOD-323 Package Outline & Dimensions

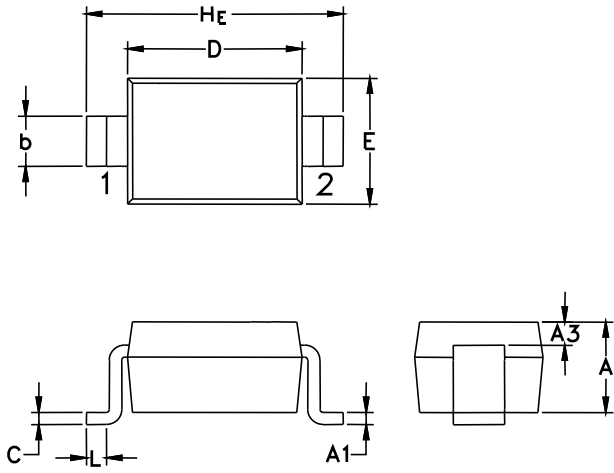

Symbol	Millimeters			Inches		
	Min.	Nom.	Max.	Min.	Nom.	Max.
A	0.80	0.90	1.00	0.031	0.035	0.040
A1	0.00	0.05	0.10	0.000	0.002	0.004
A3	0.15 REF			0.006 REF		
b	0.25	0.32	0.40	0.010	0.012	0.016
C	0.089	0.12	0.177	0.003	0.005	0.007
D	1.60	1.70	1.80	0.062	0.066	0.070
E	1.15	1.25	1.35	0.045	0.049	0.053
L	0.08	--	--	0.003	--	--
HE	2.30	2.50	2.70	0.090	0.098	0.105

Soldering Footprint

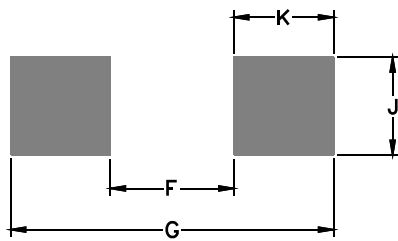

Symbol	Millimeters	Inches
F	1.60	0.063
G	2.85	0.112
J	0.83	0.033
K	0.63	0.025